

Self-Potential and Induced Polarization - Key points

Compared to ground **resistivity** in the preceding lectures, we will now be looking at **polarization properties** of the subsurface

- ▶ Self-potentials (SP) – **produced by natural electric sources**
 - ▶ Types
 - ▶ Origins
 - ▶ Measurement
 - ▶ Interpretation
 - ▶ Examples
- ▶ Induced polarization (IP) – related (but also quite different) effects **produced by controlled sources**
 - ▶ Origins
 - ▶ Measurement
 - ▶ Interpretation
 - ▶ Examples
- ▶ **Reading:**
 - ▶ Reynolds, Chapters 8 and 9
 - ▶ Dentith and Mudge, Sections 5.4 – 5.5

Self-potential (SP)

- ▶ If you go out to the field and measure electric potentials (relative to infinity) occurring naturally, **without any obvious source**, you will see the variations of the “Self-Potential”
- ▶ Characteristic SP values are caused by **certain minerals**:
 - ▶ Sulphide ores (pyrite, chalcopyrite, pyrrhotite, sphalerite, galena)
 - ▶ Graphite ore bodies
 - ▶ Magnetite and other **electronically conducting minerals**
 - ▶ **Coal**
 - ▶ **Manganese**
 - ▶ Quartz veins, pegmatites

} **Negative, ~hundreds mV**
- ▶ SP can be due to **background (host) rock** (these may be of primary interest in hydrogeological investigations)
 - ▶ Fluid streaming, geochemical reactions
 - ▶ **Bioelectric (plants, trees)**
 - ▶ **Groundwater movement**

} **Positive/negative, ≤ 100 mV**
} **Negative, ≤ ~ 300 mV**
} **Positive/negative, up to hundreds mV**
- ▶ **Topography** } **Negative, up to 2V**

Origin of self-potentials #1 - electrochemical

- ▶ **Groundwater** causes various processes leading to self-potentials:
 - ▶ Forms an **electrolyte** (supports **flows of free ions** and **oxidation-reduction reactions**)
 - ▶ Acts as a solvent for many materials
 - ▶ Supports electrochemical reactions

- ▶ **Oxidation and reduction of Fe** reactions occur below and above the water table, respectively
 - ▶ These reactions produce upward flow of electrons within the body
 - ▶ As a result, current j circulates downward through the interior of the body and upward through host rock
 - ▶ These currents cause charges and potentials above and below the body
 - ▶ These charges cause the self-potentials measured on the surface or in a borehole

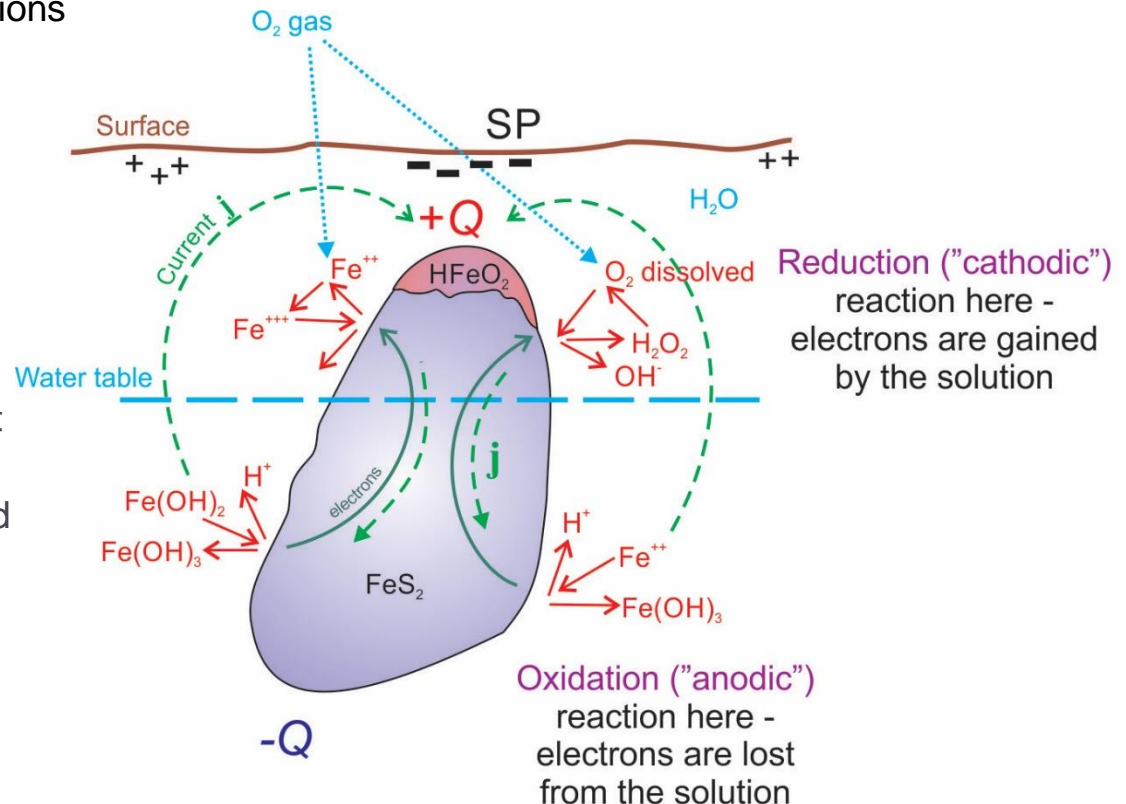

Origin of self-potentials #2 - electrokinetic

- ▶ Flows of conductive groundwater themselves involve electrical phenomena
- ▶ When viscous fluid flows along a boundary, a difference in the potentials is developed across the boundary layer (between the moving flow and rock)
- ▶ This potential is called ζ -potential, electrokinetic, electrofiltration, or streaming potential
- ▶ The formula for this potential difference is:

$$\Delta V_k = C_k \frac{\varepsilon \rho}{4\pi\eta} \delta P$$

where:

ε is the dielectric constant of the fluid;

ρ – its resistivity;

η – its viscosity;

δP – Bernoulli pressure difference between static and moving fluid (lower pressure in moving fluid);

C_k – electrofiltration coupling coefficient.

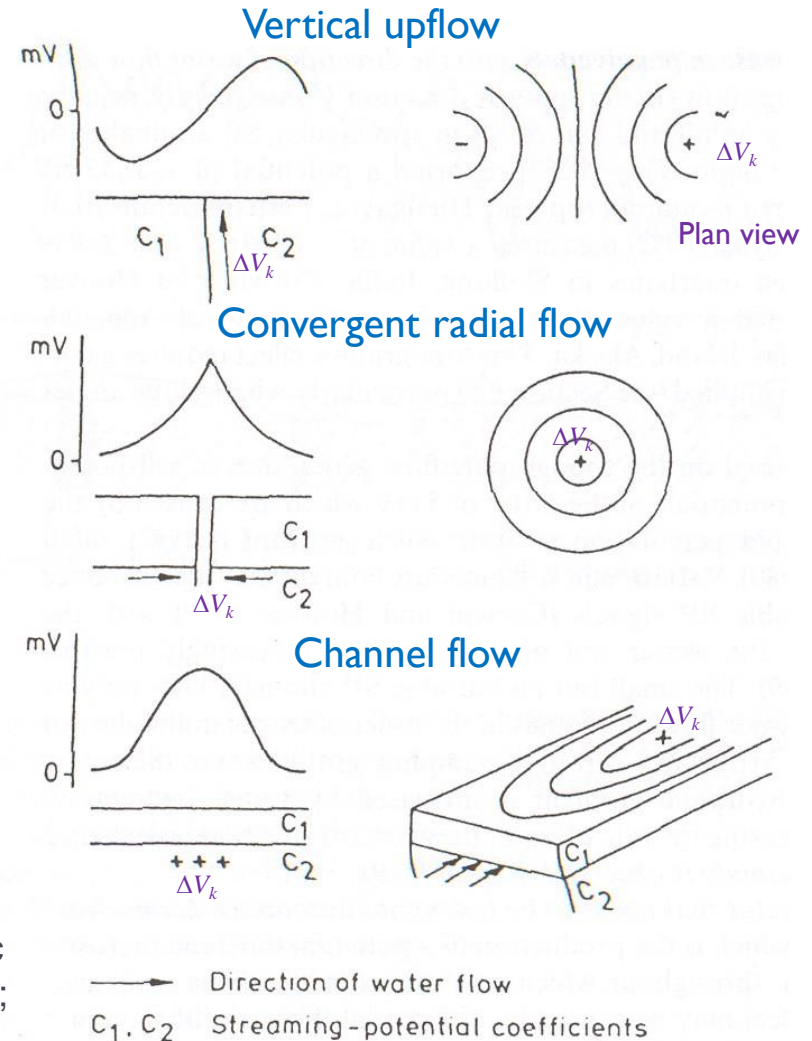

Measurement of self-potentials

- ▶ Using 2-electrode pairs (one at infinity)
 - ▶ Often combined with IP surveys
- ▶ Electrodes should be chemically-neutral and **non-polarizable**
 - ▶ Metal in a saturated solution of its own salt, such as **Cu** in **CuSO₄**
 - ▶ Porous bottom of the electrode pot allows the solution to leak through slowly and make contact to the ground
- ▶ Need a **high-resistance receiver**
 - ▶ Digital DC meter with input impedance $\sim 10^8 \Omega$
- ▶ **Field procedure:**
 - ▶ Check electrodes periodically side-by-side for < 2 mV differences
 - ▶ Leap-frog electrodes across the strike of the measured anomaly
 - ▶ Or use a fixed base station to check the electrodes periodically
- ▶ SP measurement stations can be from ~ 30 m to several km apart

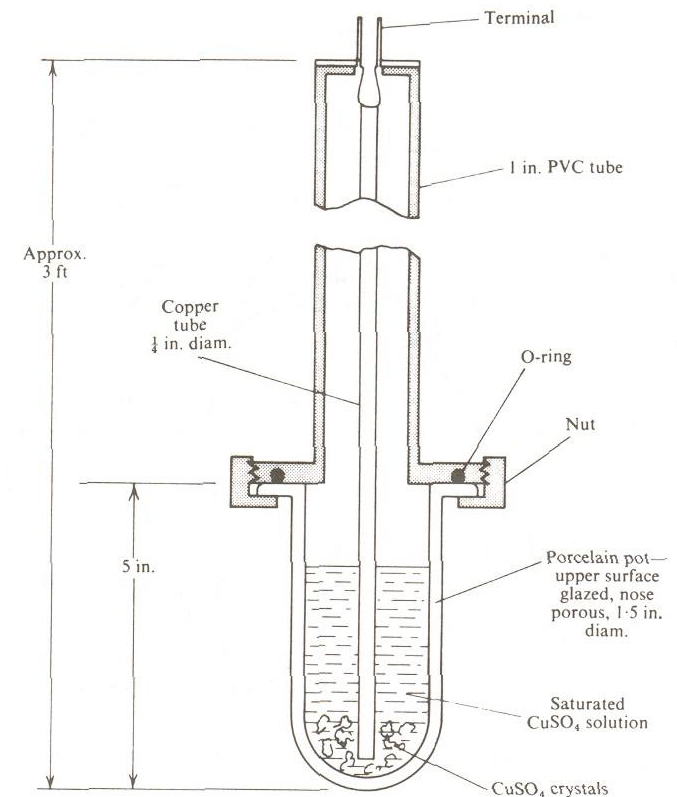

SP interpretation

- ▶ Often qualitative, looking for the main structure (details are usually too complex)
- ▶ Source zone is approximated as a **dipole** (polarized bar (+,-) in plot below)
- ▶ Depth of the source is estimated from half-magnitude width of the anomaly ($w_{1/2}$)
- ▶ Orientation, shape, and plunge estimated from the asymmetry of the anomaly
 - ▶ Can try methods you used in Lab #3

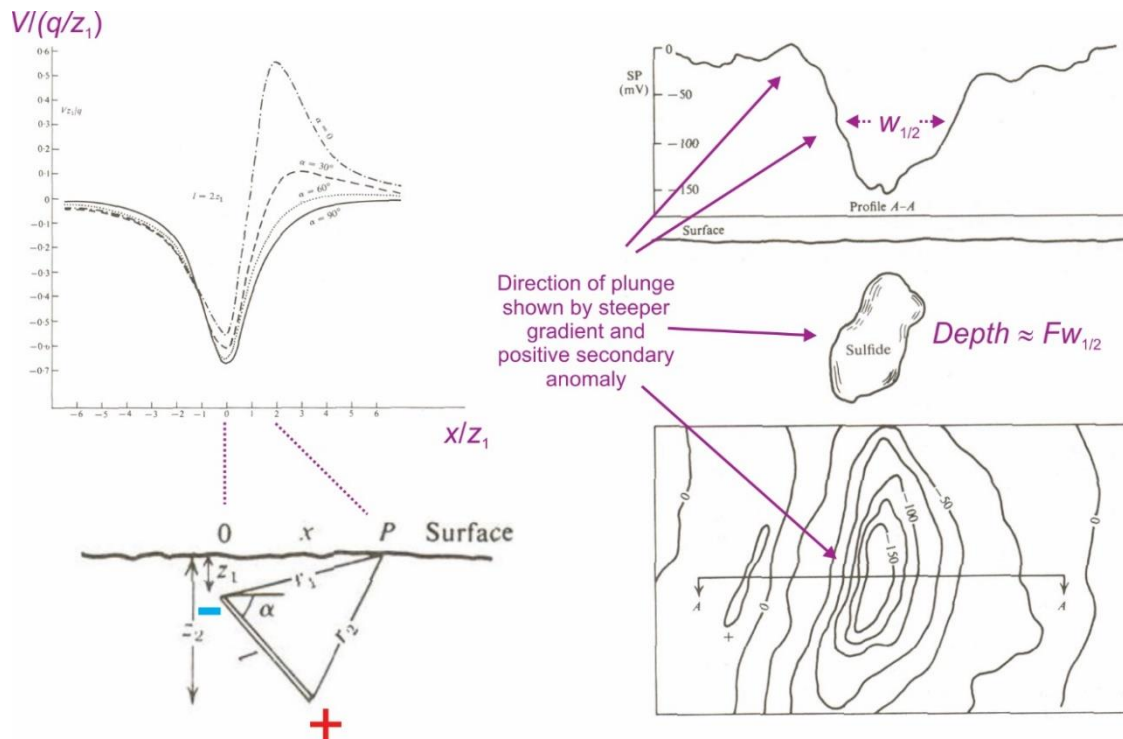

- Note that **oppositely to gravity** (what you saw in Lab #3), the direction of plunge is **toward the zone of steep gradients** of the field (densely spaced contours) and not toward the broader contours
- **This is because the source is a dipole** here, with the deeper end of the body having **opposite polarity**

Effect of overburden on SP

- ▶ Clay is conductive and tends to equalize electrical potentials over an area
- ▶ Therefore, clay within overburden can reduce the SP response from deeper structures. See the surface profile in the bottom right.
- ▶ Similarly, clay greatly complicates the use of GPR (ground-penetrating radar) on tills in Saskatchewan

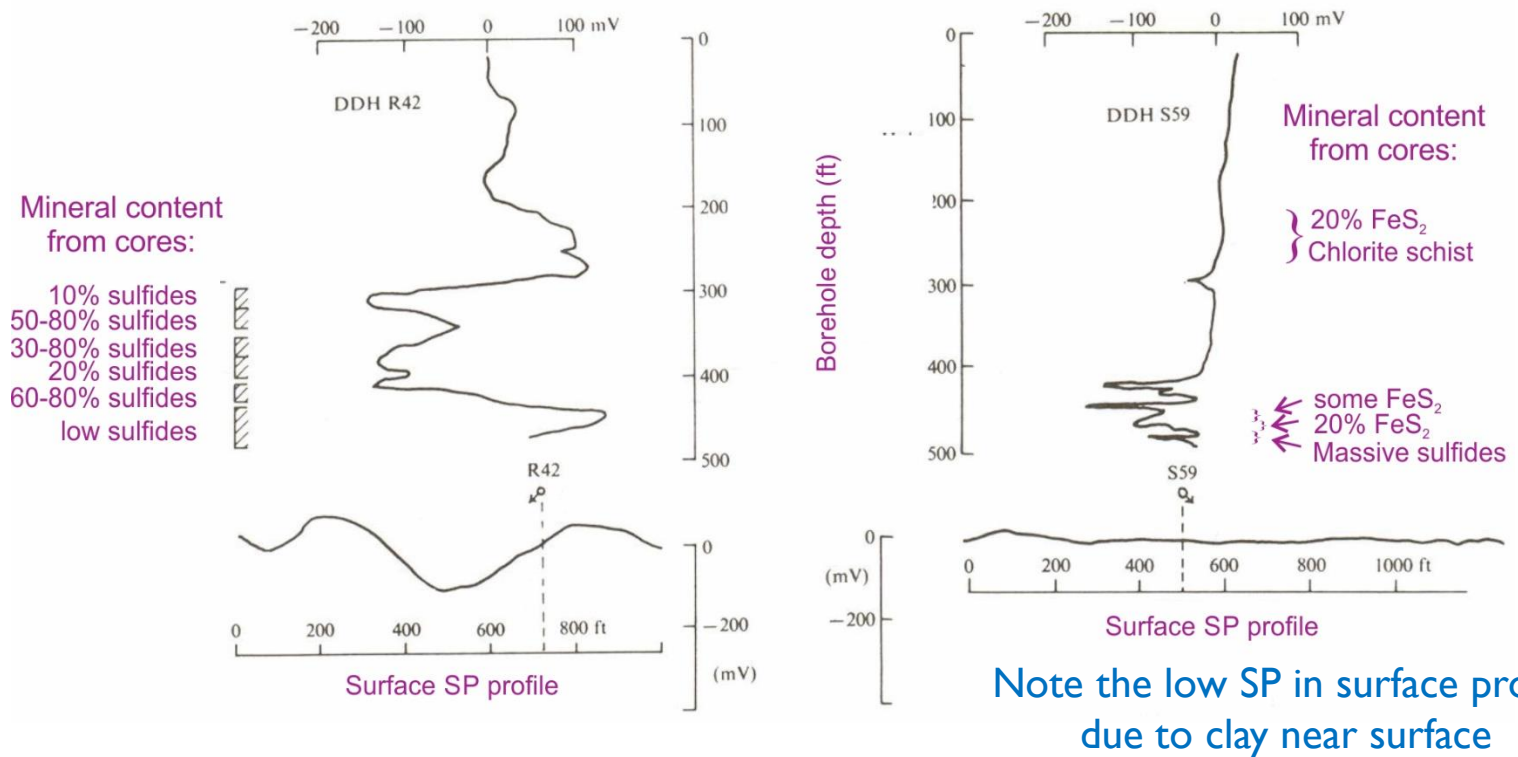

Example #1

- ▶ Four graphite bodies interpreted in folded gneiss (Meiser, 1962)

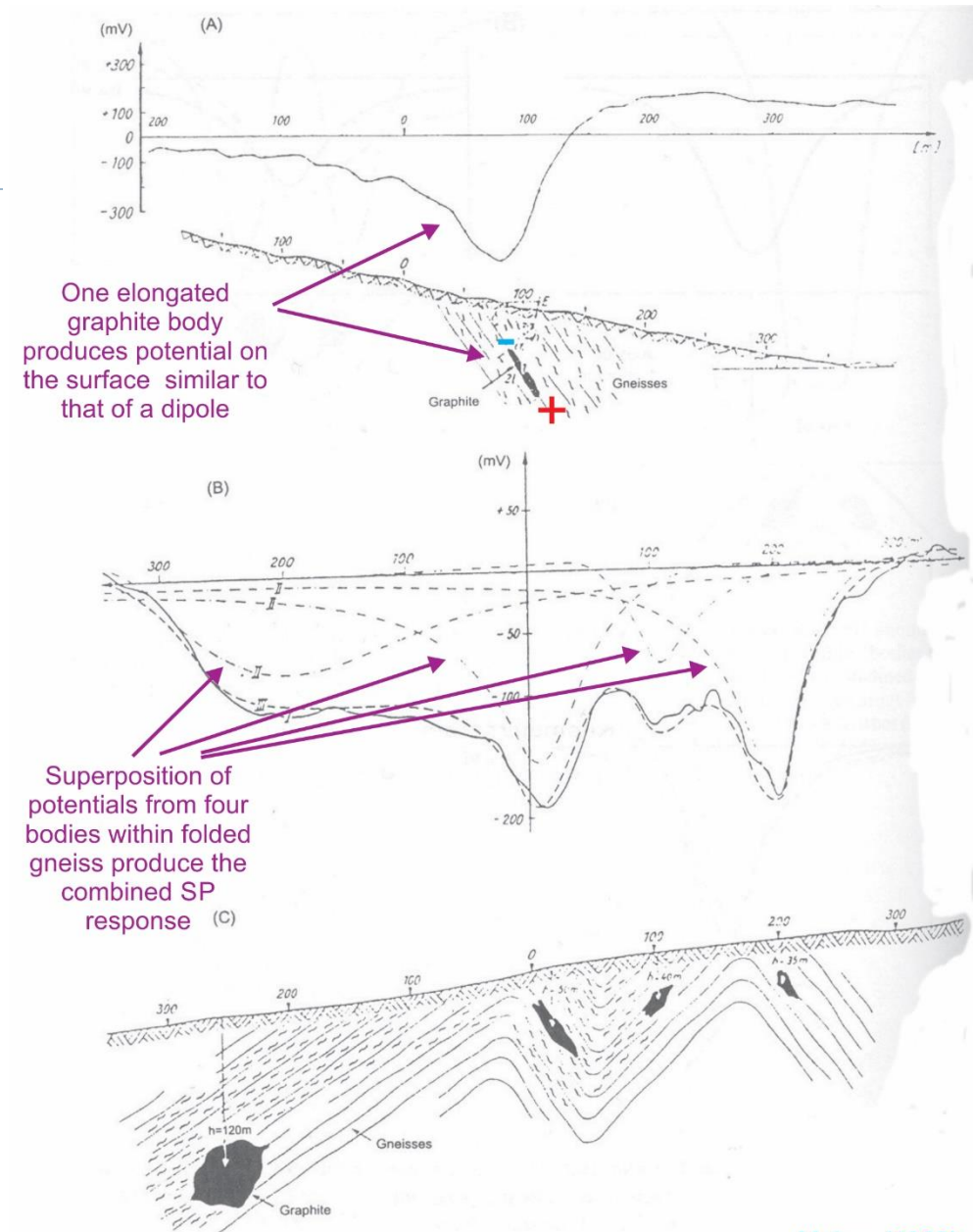

Meiser (1962)

Example #2

- ▶ Very strong negative SP anomalies caused by massive sulphides (Sonnetere area, Quebec; from Telford et al. text)

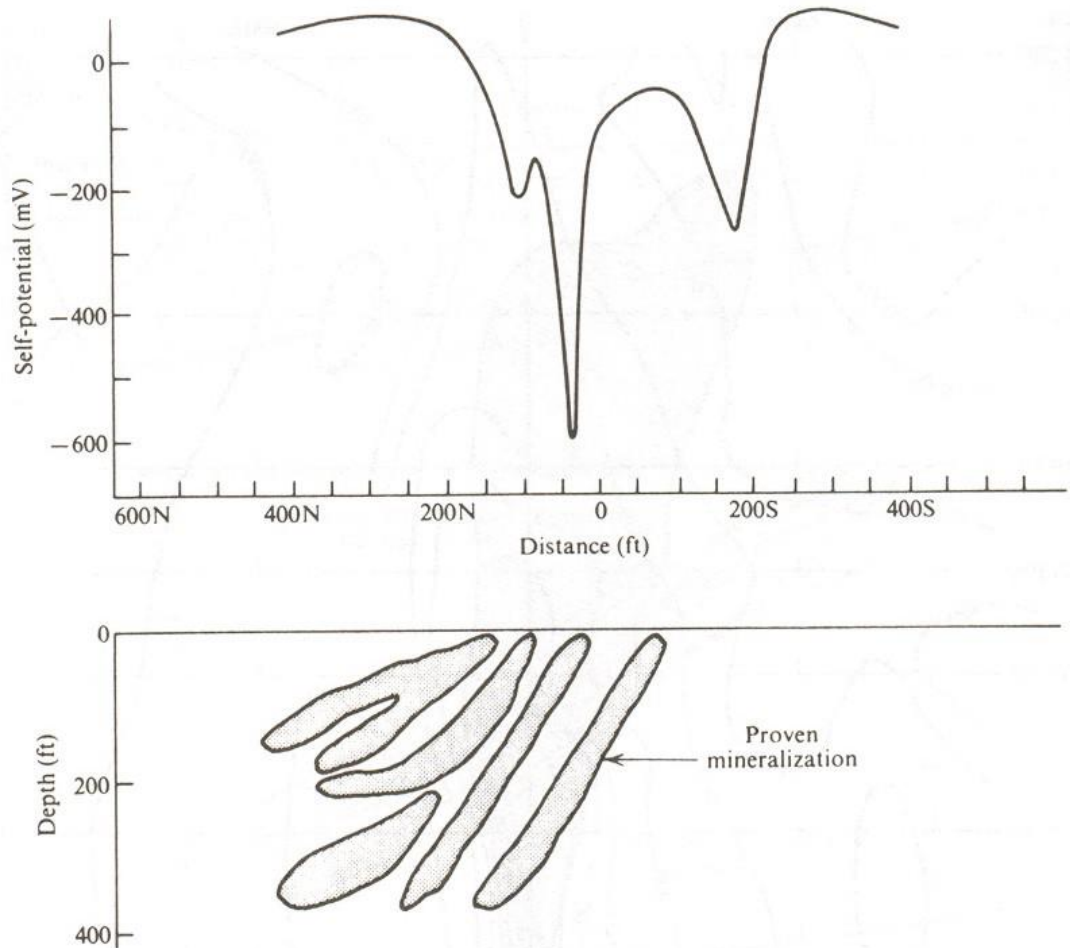

Induced polarization (IP)

- ▶ IP effects are caused by **dielectric** rather than resistivity or electrochemical/electrokinetic properties of materials discussed before
- ▶ The idea of IP is in **using current sources and electrode arrays similar to resistivity but with time-variant currents**
 - ▶ **Time-variant** current is injected by electrodes A and B and time-dependent voltages between electrodes M and N are recorded
 - ▶ This allows doing **sounding and profiling** and creating pseudo-sections, as in resistivity work
- ▶ After current is switched off (or turned on), the voltage between potential electrodes takes from 1 second to 1 minute to decay (or build up). See plot on the right
 - ▶ The dielectric ground acts somewhat like a capacitor causing the time-delayed “relaxation”, or “**overvoltage**” effect

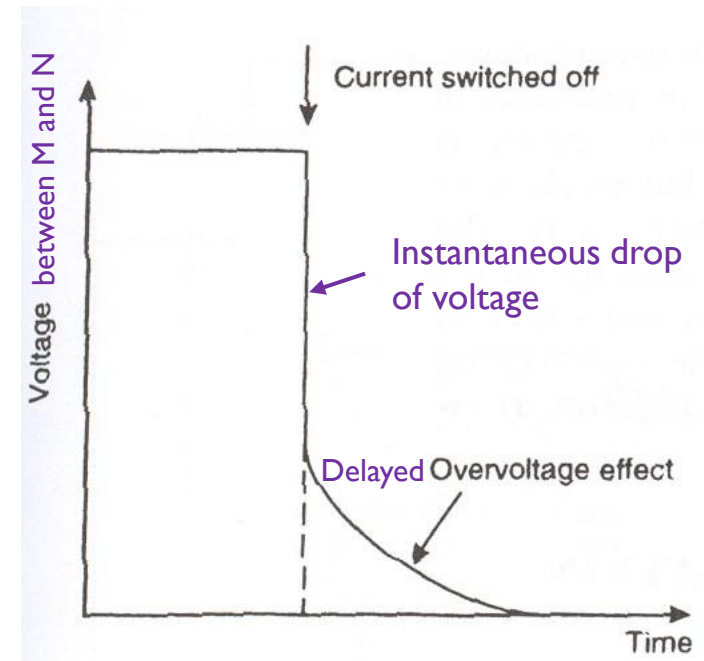

Applications of IP

- ▶ Applications of IP basically include all **polarizable** and **not very conductive** ore bodies
- ▶ Applications are usually compared to resistivity
 - ▶ However, IP effects are sensitive to grain sizes and rock texture
 - ▶ Often allow detecting features not noticeable with resistivity
- ▶ Typical applications are metallic deposits with low EM (current-related) anomalies and high resistivity
 - ▶ Disseminated Cu, Pb-Zn ores, Au;
 - ▶ Pyrite, chalcopyrite, magnetite, clay, graphite

IP-related material properties

- ▶ Material properties measured by IP are related to the ability of the disseminated material to polarize (attain charge on sides of a particle)
- ▶ Measured by empirical quantities discussed in next slides

Note the unit of conductance:
 “mho” = 1/Ohm =
 = Siemens

“Metal factor”

“Chargeability”

Material	Chargeability (ms)
Ground water	0
Alluvium	1 – 4
Gravels	3 – 9
Precambrian volcanics	8 – 20
Precambrian gneisses	6 – 30
Schists	5 – 20
Sandstones	3 – 12
Argillites	3 – 10
Quartzites	5 – 12

Material	Metal factor (mhos/cm)
Massive sulfides	10,000
Fracture-filling sulfides	1,000 – 10,000
Massive magnetite	3 – 3,000
Porphyry copper	30 – 1,500
Dissem. sulfides	100 – 1,000
Shale-sulfides	3 – 300
Clays	1 – 300
Sandstone – 1 – 2% sulfides	2 – 200
Finely dissem. sulfides	10 – 100
Tuffs	1 – 100
Graphitic sandstone and limestone	4 – 60
Gravels	0 – 200
Alluvium	0 – 200
Precambrian gneisses	10 – 100
Granites, monzonites, diorites	0 – 60
Various volcanics	0 – 80
Schists	10 – 60
Basic rocks (barren)	1 – 10
Granites (barren)	1
Groundwater	0

Mechanism of Induced Polarization (IP)

- ▶ IP effects are sensitive to **dielectric** rather than resistivity or electrochemical/electrokinetic properties of materials we discussed before
- ▶ Disseminated (poorly conductive) ore body is polarized (develops surface charges; + and - in Figure below) by the imposed current
 - ▶ When the current is switched off, the charges cause transient current through the conductive overburden (dashed lines).
 - ▶ These currents flow in the same direction as the primary current and cause the overvoltage effect

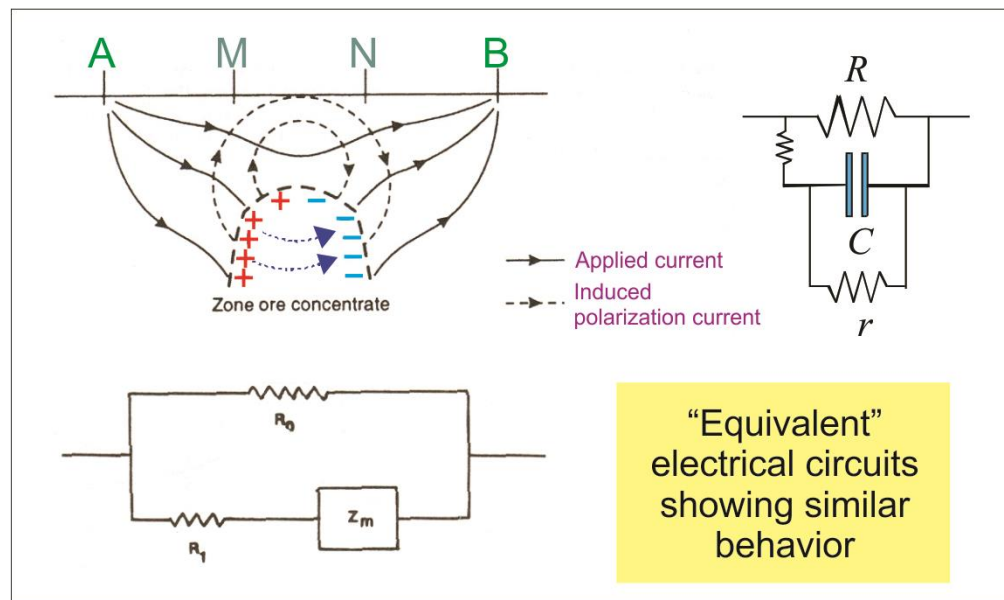

Induced Polarization due to Resistivity Contrasts

- ▶ Here is a simple example how overvoltage occurs in a medium with resistivity layering (“faradic”, i.e. freely moving charge effect)
 - ▶ Immediately after the voltage is applied (time $t = 0$), electric field E is constant, and currents are greater within layers with smaller resistivity (yellow)
 - ▶ This causes accumulation of charges on layer boundaries
 - ▶ Resistance V/I has a certain starting value
 - ▶ The accumulating charges cause the E and current to reduce with time
 - ▶ With reducing current, total resistance V/I gradually increases (overvoltage effect)
 - ▶ After sufficient time, the current becomes constant in all layers and resistance V/I reaches maximum (red, $t = \infty$)

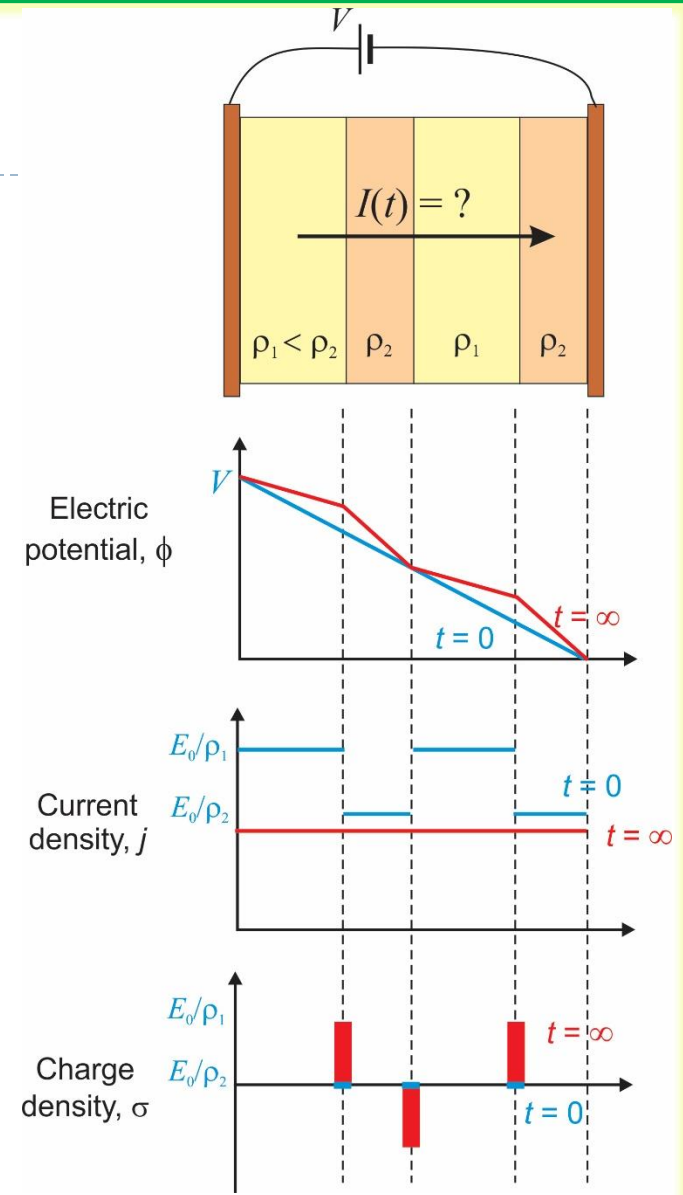

Microscopic mechanisms of Induced Polarization

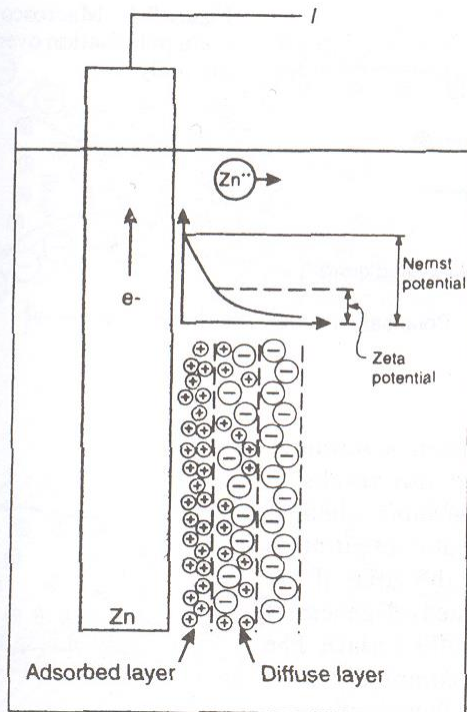

Electrode polarization by “diffuse boundary layer”

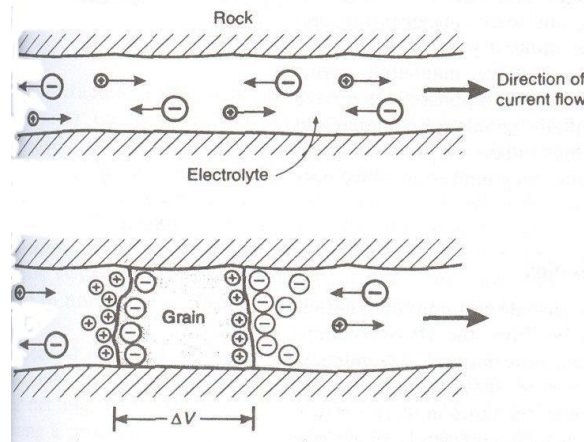

Grain polarization on current flow impediments

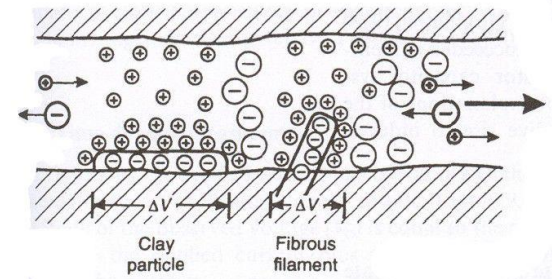

Electrolytic partially-permeable membrane polarization

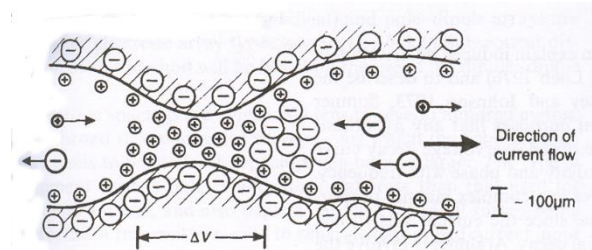

IP measurements

- ▶ There are two main types of IP measurements:
 - ▶ **Time-domain** (measuring transient time-dependent signal after switching current on or off)
 - ▶ **Frequency-domain**
 - ▶ “Variable-frequency IP” (using **apparent resistivities** at two frequencies, both < 10 Hz)
 - ▶ “Phase-domain IP” (measuring phase delays between source current and voltage)
 - ▶ “Spectral IP” (measuring phases and amplitudes at frequencies 10^{-3} to $4 \cdot 10^3$ Hz)
- ▶ All methods **use conventional resistivity electrode arrays**
 - ▶ Most commonly in the **double dipole** configuration
 - ▶ Schlumberger arrays are used for broad reconnaissance surveys
- ▶ As with SP, non-polarizable electrodes are usually required

Time-domain IP measurement

- ▶ The method mentioned in the preceding slide is called the “time-domain” IP:
 - ▶ Current is switched on, off, and reversed for selected intervals in a “square wave” pattern (plot on the left)
 - ▶ Each time the current is switched off, “chargeability” M is measured from the series of the induced-voltage $V(t)$ readings (plots on the right)

“Chargeability”:
$$M = \frac{\int_0^{\infty} V(t) dt}{V_0} \text{ [ms]} \quad \text{or:} \quad M = \frac{\sum_{\text{gates } i} V(t_i) \Delta t_i}{V_0} \text{ [ms]}$$

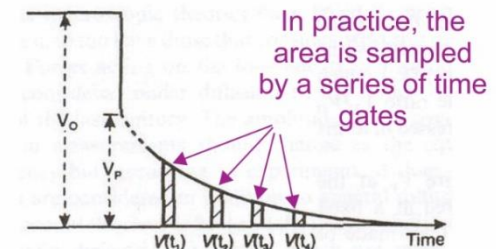
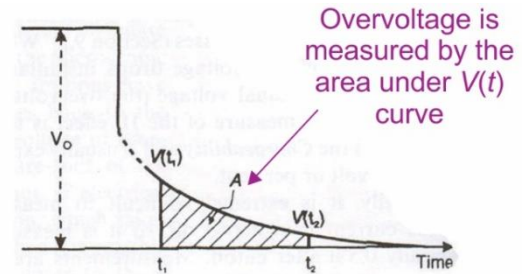
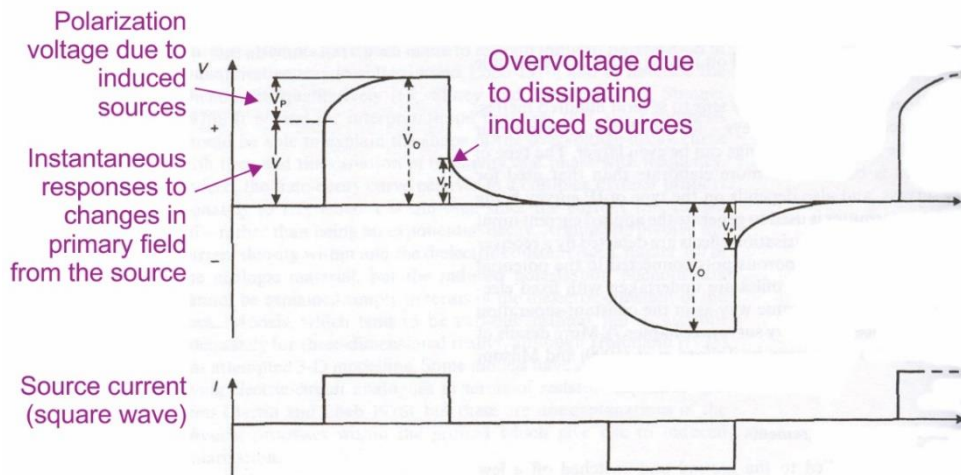

Frequency-domain IP measurement

- ▶ Since IP is measured from time variations of the induced voltage, it is also convenient to use harmonic (sine) oscillations rather than square waves
 - ▶ This method is called “frequency-domain”, “spectral”, or “complex-resistivity” IP

- ▶ Method:

- ▶ Apply oscillating source current $I(t)$ at frequency f from ~30 to 4000 Hz
- ▶ The measured voltage $V(t)$ will be at the same frequency; evaluate the **apparent complex impedance (resistivity, or “impedivity”)**:

$$Z(\omega) = \frac{V(\omega)}{I(\omega)} k$$

where k is the geometry factor for the electrode array, and $\omega = 2\pi f$.

- ▶ Look for the “**dispersion**” of $Z(\omega)$ (difference between low-frequency and high-frequency levels; plot on the right)
 - ▶ This dispersion gives the chargeability M
 - ▶ This dispersion is also called the “frequency effect” (see next slides)

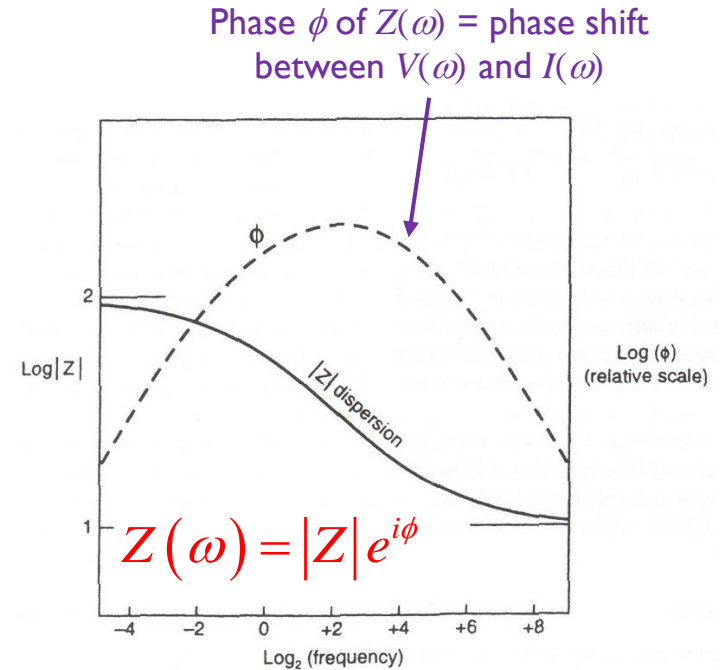

Cole-Cole model for complex resistivity

- ▶ The so-called “Cole-Cole” model is often used to describe systems with relaxation and dispersion
- ▶ For complex resistivity as a function of angular frequency $\omega = 2\pi f$, this model is:

$$Z(\omega) = \rho_0 \left[1 - M \left(1 - \frac{1}{(1 + i\omega\tau)^c} \right) \right]$$

where ρ_0 is the limit at $\omega \rightarrow 0$, i.e. ordinary DC resistivity,

M is the **chargeability** depending on mineral content (the same as in time-domain measurements on preceding slide)

c is the **Cole-Cole exponent** (0.2 to 0.6) depending on grain sizes and distribution

- With $c = 1$, the model is called “Debye” (upper curve in the figure)

τ is the relaxation time (10^{-4} to 10^4 s) **depending on resistivity and grain size**

Complex plane of $Z(\omega)$

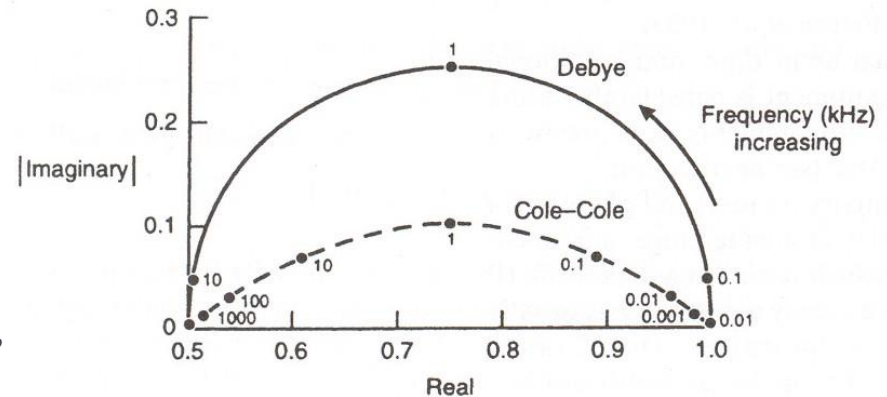

If you plot $Z(\omega)$ from field data, the spectrum should look something like this. ρ_0 would be judged from $\max\{\text{Re}Z(\omega)\} = Z(0)$, and M – from the magnitude of $\text{Im}Z$

“Variable frequency” IP measurement

- ▶ As shown in preceding slides, the apparent complex-valued resistivity $\rho_a(f)$ decreases with frequency. The **relative** decrease of ρ_a between some frequencies f_0 and f_1 is called the “**frequency effect**”:

$$\text{Frequency Effect} = FE = \frac{\rho_a(f_0) - \rho_a(f_1)}{\rho_a(f_1)} \quad [\text{unitless or \%}]$$

- ▶ Frequency effect is also expressed as the “**Metal factor**” (difference in apparent conductivities across the frequency range). The metal factor has units of conductivity:

$$\text{Metal Factor} = \frac{2 \times 10^5 \pi}{\rho_a(f_0)} FE = 2 \times 10^5 \pi [\sigma_a(f_1) - \sigma_a(f_0)] \quad \left[\frac{\text{Siemens}}{m} \right]$$

- ▶ This measurement only requires two measurements at frequencies much lower (f_0) and much higher (f_1) than all relaxation frequencies in the study area
 - ▶ (However, implementing these end-limit measurements may be tricky if there is some noise in the study area)

Displays of IP data

- ▶ IP data are usually displayed similar to static quasi-resistivity ($\rho_a(f_0)$) and interpreted also together with resistivity
- ▶ In the form of pseudo-sections or by inversion

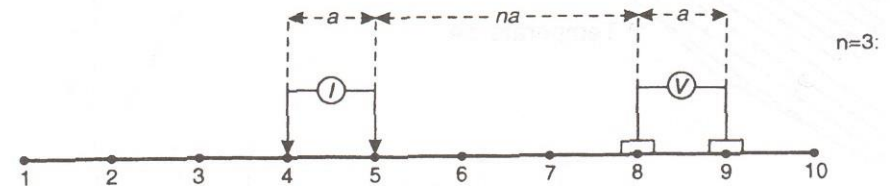

Pseudo-sections of
 apparent resistivity
 (upper half)
 and IP
 chargeability of
 metal factor
 (lower half)
 for a double
 dipole array

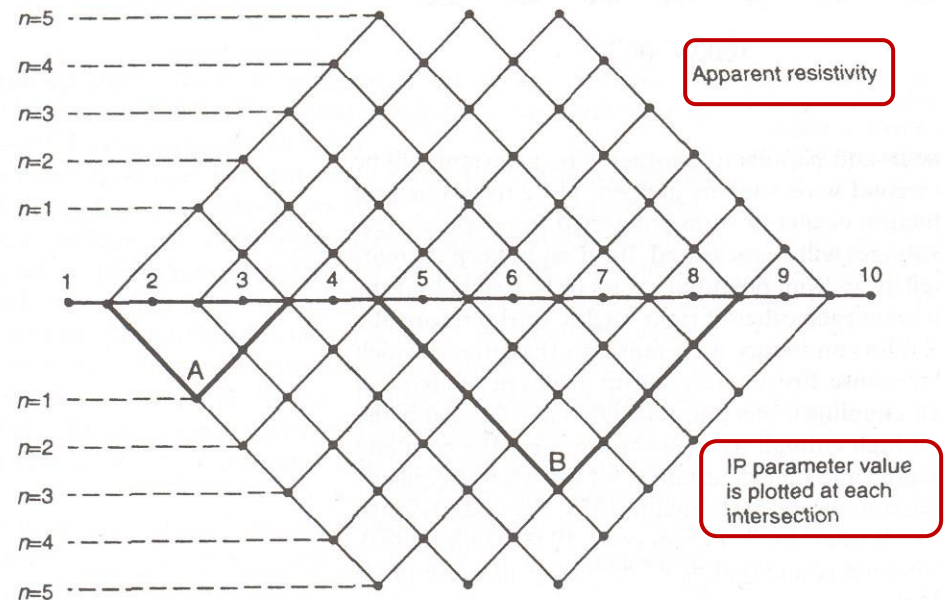

Example #1 – laboratory (Ogilvy and Kuzmina, 1972)

- ▶ Freshwater lens in sand is well detected by IP chargeability M_a (peak in plot A)
- ▶ For seawater lens, apparent resistivity ρ_a and M_a show only broad anomalies (plot B)
- ▶ However, the ratio of overvoltages at periods 0.5 and 5 minutes (denoted Δ) detects the seawater lens well (peak in plot B)
 - ▶ So as you see, you may need to be creative when selecting the range of chargeability time gates in order to see the useful response

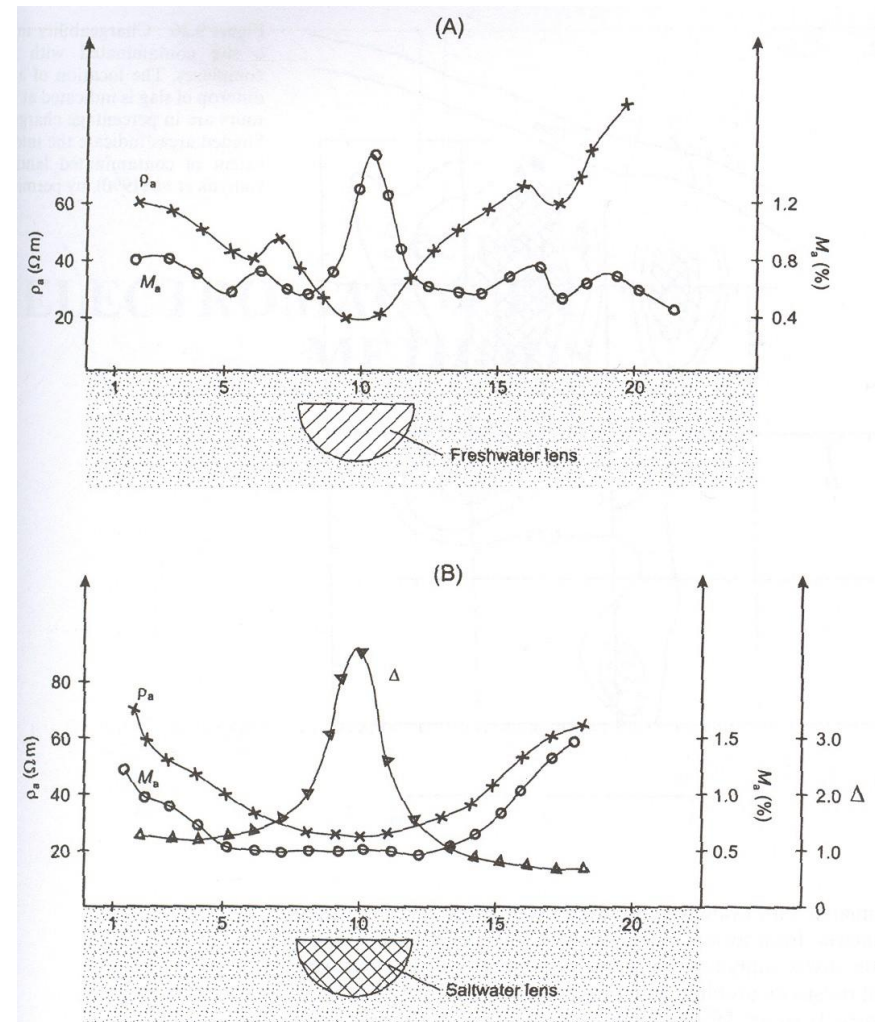

Example #2 – field

- ▶ Identification of a contamination with cyanide complexes (slags from plating works; Cahyna et al., 1990)
 - ▶ Resistivity surveys did not detect contamination
 - ▶ IP chargeability detected both the known and unknown slag deposits (shaded in the map)

